

SUNTUF®

The Ultimate In Performance and Durability.

Palram Products Compared	PALRUF® GOOD	SUNTOP® BETTER	SUNTUF® BEST
Impact resistance	Good	Better	Best
Chemical resistance	Best	Good	Good
Snow load capacity	Good	Better	Best
Temperature range	-4°F to 120°F (-20°C to 49°C)	-40°F to 212°F (-40°C to 100°C)	-40°F to 212°F (-40°C to 100°C)
UV Protection	100%	100%	100%
Flame resistance	Good	Good	Good
Cost effectiveness	Good	Better	Best
Warranty	5 Year Limited	10 Year Limited	Lifetime Limited

Typical Uses Around The Home & On The Farm

- Canopies
- Greenhouses
- Pool enclosures
- Awnings
- Car ports
- Shade canopies
- Skylights
- Deck covers
- Animal shelters
- Walkway covers
- Patio covers
- Tool sheds

Just a few ideas of what you can do with **SUNTUF Corrugated Panels!**



SUNTUF® CORRUGATED POLYCARBONATE SHEET Limited Lifetime Warranty

SUNTUF Polycarbonate Panels are lifetime warranted from the purchase date, not to lose more than 10% of their light transmission (when tested in accordance with ASTM D 1003-77). The above warranty shall apply only if the panels are installed, used and maintained in accordance with Palram recommendations and specifications. Suntuf also features a limited ten year warranty against hail damage. For complete warranty details, contact Palram at 1-800-999-9459, or visit us online at www.PalramAmericas.com.

Distributed by:



PALRAM AMERICAS
9735 Commerce Circle
Kutztown, PA, 19530 USA
Tel: 800.999.9459
palramamericas@palram.com



Form 402-7-06/16/18/W

©2016 SUNTUF is a trademark of PALRAM.

www.PalramAmericas.com



SUNTUF® Corrugated Polycarbonate Sheet



Build On.



www.PalramAmericas.com

SUNTUF®

Corrugated Polycarbonate Sheet

The Ultimate In Performance and Durability.

SUNTUF corrugated sheets offer high light transmission, strength, and a wide service temperature range.

Features and Benefits:

- Impact Resistant – Virtually unbreakable
- Up to 90% light transmission
- Long term weather and UV resistant
- Wide service temperature range
- Better UV protection than sunscreens
- Lightweight
- Easy to work with and install
- Limited lifetime warranty against yellowing/loss of light transmission; 10 years against hail damage

Regulatory Code Compliance Certification

Organization	Standard	Classification
CCMC	NBC 2010 (Canopy Covering)	Compliant (CCMC Eval. Rep. 13450-R)
Miami Dade County	FBC 2014 (Canopy Covering)	NOA# 15-1207.08
ICC (Int'l Code Council)	IBC 2012 (Light Transmitting Plastics)	ESR-1893
City of Los Angeles	LABC 2014 (Light Transmitting Plastics)	RR 25298

For detailed information on physical properties, please visit www.PalramAmericas.com/Suntuf



Available in Eight Colors* & Six Light Transmission Levels



7 Standard Sizes

26" wide – 6', 8', 10' and 12'
49.6" wide – 8', 12' and 16'

Custom sizes available subject to minimum quantities.

*Some colors and sizes available by special order only. Consult with retailer for details or contact Palram at (800) 999-9459.

Accessories to Complete Your Project

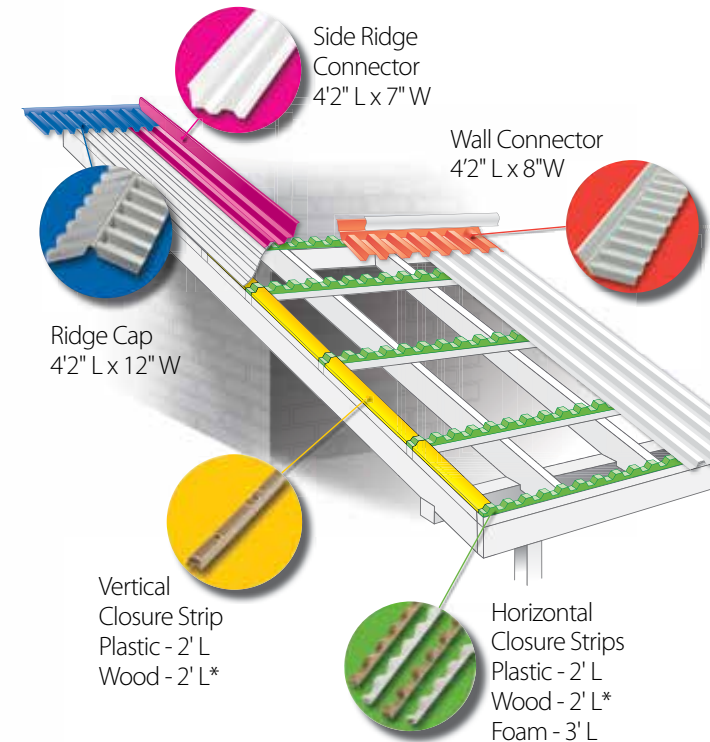

*Available in select markets only.

Special EPDM Washered Fasteners



Before You Begin

Make sure the color of all panels match. Be sure panel and horizontal closure support strip fit together... **SUNTUF polycarbonate panels are square.** Snow, wind and weather loads should be considered when designing the slope degree of your structure (Min. 1½" in 12"). Before installation, check local building codes for relevant specifications and recommendations. Follow local codes at all times.

TRANSPORTATION, handling and storage: Do not transport, leave or store panels in direct sun before or during installation. For outdoor storage, cover securely with a white opaque polyethylene sheet to avoid solar heat gain between the panels. Sunlight is magnified when passing through uncovered sheets, increasing the temperature of the sheets, which leads to degradation and distortion. Penetration of water between the sheets in storage will accentuate this heat gain. Therefore, it is recommended to store the panels indoors. Panels will withstand heat when properly installed and ventilated. Store the panels stacked evenly on a horizontal flat surface with longer lengths on the bottom. Do not stack other items on top of panels. If panels are not stacked directly on floor, be sure to support evenly.

LOAD SUPPORT TABLE	Pounds per Sq. Ft.	20	30	40	50
Cross Support Bracing		36"	30"	24"	16"

FLEXIBLE ENOUGH FOR CURVED STRUCTURES: SUNTUF panels may be used in curved applications, as long as the radius of the curve is not less than 20 feet.

SUNTUF ACCESSORIES

1. SUNTUF Ridge Cap Flashing
4' 2" L x 12" W
2. SUNTUF Side Ridge Flashing
4' 2" L x 7" W
3. SUNTUF Wall Connector Flashing
4' 2" L x 8" W
4. SUNTUF Vertical Closure Strip
Plastic - 7/8" H x 1-3/16" W x 24" L
Wood - 7/8" H x 1-3/16" W x 24" L*
5. SUNTUF Horizontal Closure Strip
Plastic - 3/4" H x 7/8" W x 24" L
Foam - 3/4" H x 7/8" W x 36" L
Wood - 3/4" H x 7/8" W x 24" L*
6. Special EPDM Washered Fasteners



See information below

*Available in select markets only.

BE SURE TO CAREFULLY READ ALL INSTRUCTIONS

Installation details for a typical canopy structure

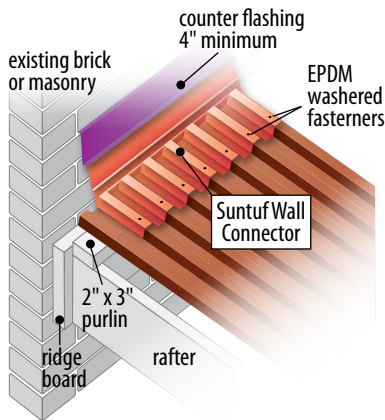

(A) Head Flashing Detail

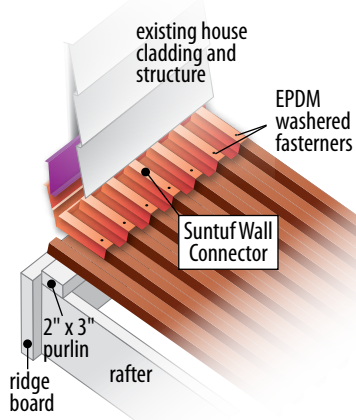

(B) Head Flashing Detail at Sided Wall

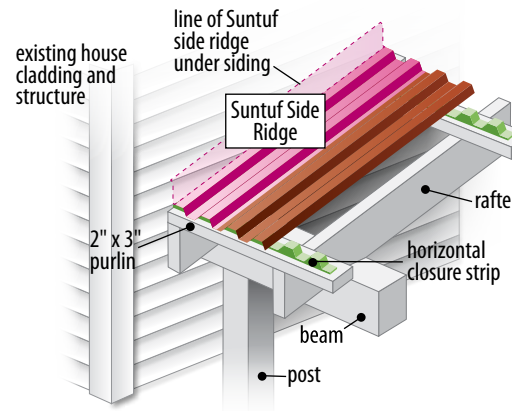

(C) Sidewall Flashing Detail

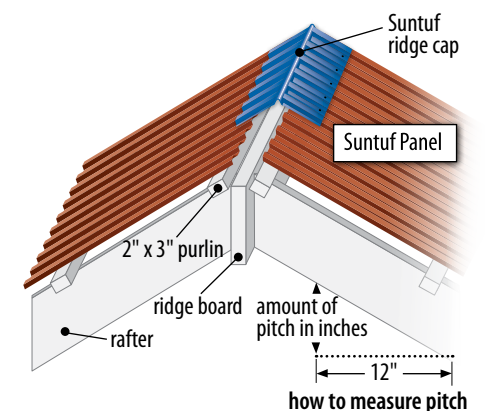

(D) Ridge Detail

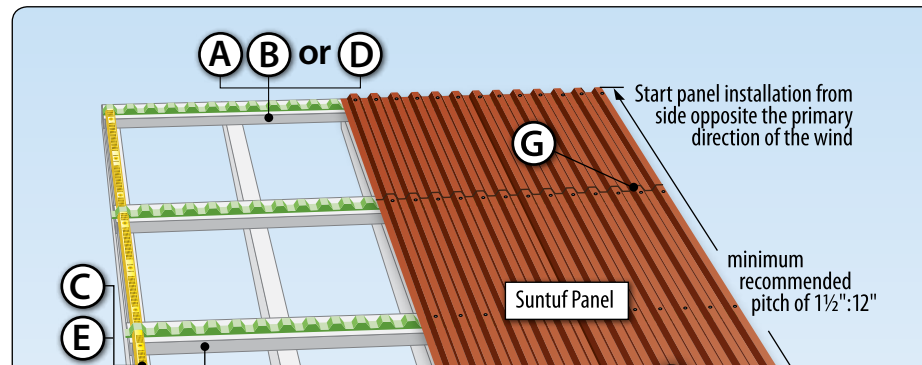
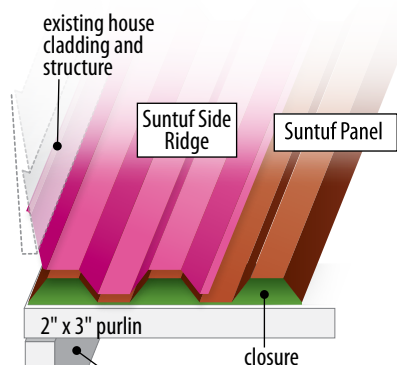

For low slope applications use a sealant approved as compatible with polycarbonate by the manufacturer.

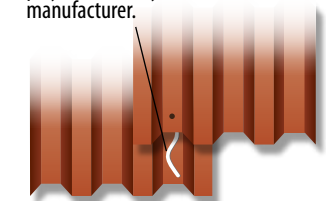

(H) Detail at Seam

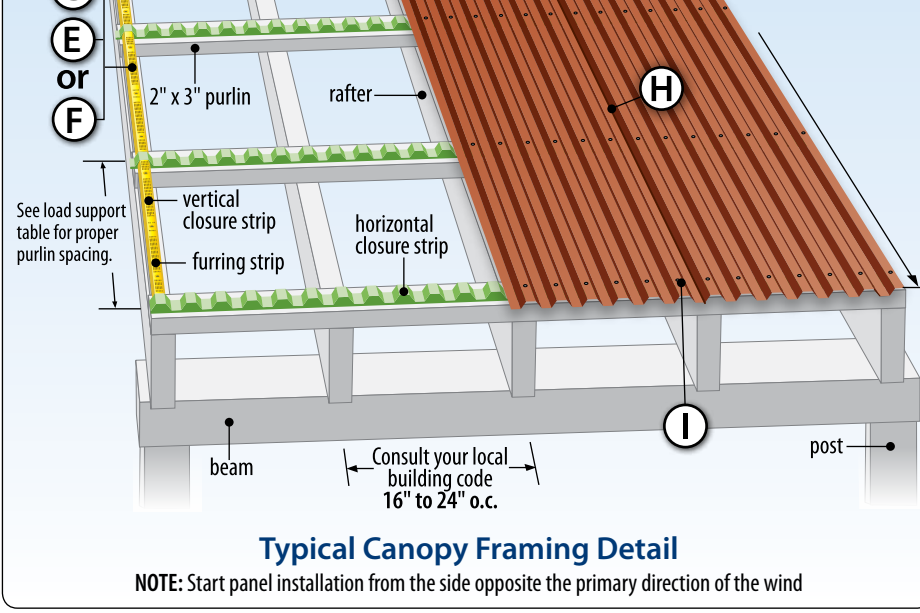
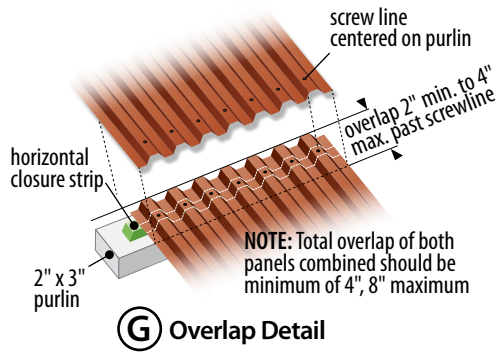
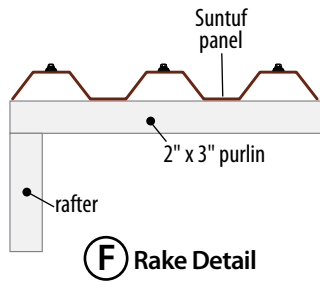
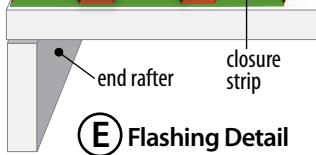

H Detail at Seam

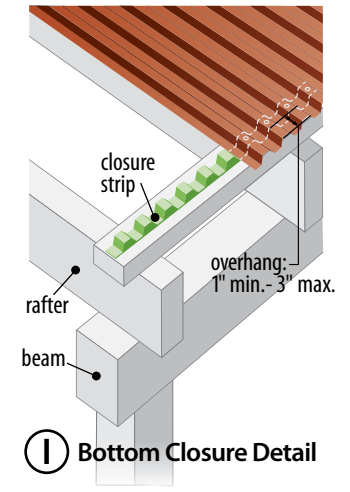

Watch the DIY Products Installation Video Online.
A video presentation of basic handling and installation for DIY corrugated products.
PalramAmericas.com/Installation-Overview/

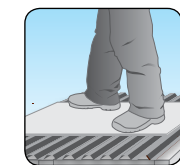

SAFETY:
Never walk on sheets.
Use a board placed across at least three rafters to spread the load

INSTALLATION NOTES:

Install panels with the label side facing toward the sky (sheet corrugations at each end will face down).

To Cut Panels: Use either a circular saw with a plywood blade reversed, a utility knife and a straight edge, or a pair of snips. Support the sheets to avoid vibration and cut at slow speed. Up to five panels can be cut with a circular saw.

Pitch: This is the amount of height in inches the rafter rises over a 12" run. Minimum slope is 1 1/2" in 12" (see figure D). Never install panels on flat roofs.

Purlins/Cross Supports: Cross supports (purlins) must be no more than 36" apart for SUNTUF. Cross supports should be at least 2" x 2" lumber.

Sealants: For SUNTUF sheets, it is recommended you use any sealant/adhesive that is recommended for polycarbonate materials. (See figure H). Also see PalramAmericas.com/Sealants/

Closure Strips: Made from either plastic, wood or foam, corrugated horizontal closure strips are required. They are used horizontally under the panels as fastener supports. Plastic corrugated horizontal closure strips are recommended. Plastic vertical closure strips are recommended for finishing the outside edges.

Inasmuch as Palram Americas has no control over the use (and/or Installation method) to which others may put this material, it does not guarantee that the same results as those described herein will be obtained. Each user of the material should make their own test to determine the suitability of the material for their own particular use. In the event of a warranty claim for product failure, Palram Americas reserves the right to inspect any or all of the sheets involved and the installation site itself while the sheets are still in their original position and have not been removed or moved or altered in any way. For a complete copy of the SUNTUF Polycarbonate Warranty, contact Palram at 1-800-999-9459 or visit us on line at www.PalramAmericas.com.

©2012-16 Palram Americas. All Rights Reserved.

Ventilation: Ventilation is recommended to avoid condensation and heat build up.

Fasteners: Use Palram brand EPDM Washered fasteners only. NEVER use nails. Pre-drill all fastener holes with a 1/4" drill bit to accommodate for the thermal movement of the panel. Failure to accommodate thermal movement will cause buckling of the sheet. Attach fasteners on the crown of every other rib in the horizontal direction. In high wind areas, fasten on the crown of every rib. Use 2" fasteners for all roof applications. DO NOT overtighten fasteners causing the rubber washer to compress.

TIP: Tighten all fasteners until they are "snug". If the EPDM washer becomes deformed, the fastener is too tight!



Care and Maintenance: Avoid contact with chemicals, paints, adhesives or other synthetic materials that are incompatible with polycarbonate. Never use glass cleaners with ammonia, or ammonia based products. Clean with lukewarm soapy solution using a soft cloth or sponge. Do not use abrasive brushes as these will mark the surface. For full care and maintenance info, see PalramAmericas.com/Tech/



Installation Overview